

# INSTRUCTIONS

## *for the* Model GVL GLASS-VU LOADER

Rev 4.7 06/23/15



Model: GVL-10

MAGUIRE PRODUCTS INC.  
11 Crozerville Road  
Aston, PA 19014 USA  
610-459-4300

**MAGUIRE**  
The perfect blend of simplicity and control.

# Installing the GVL GlassVu Loader ---General---

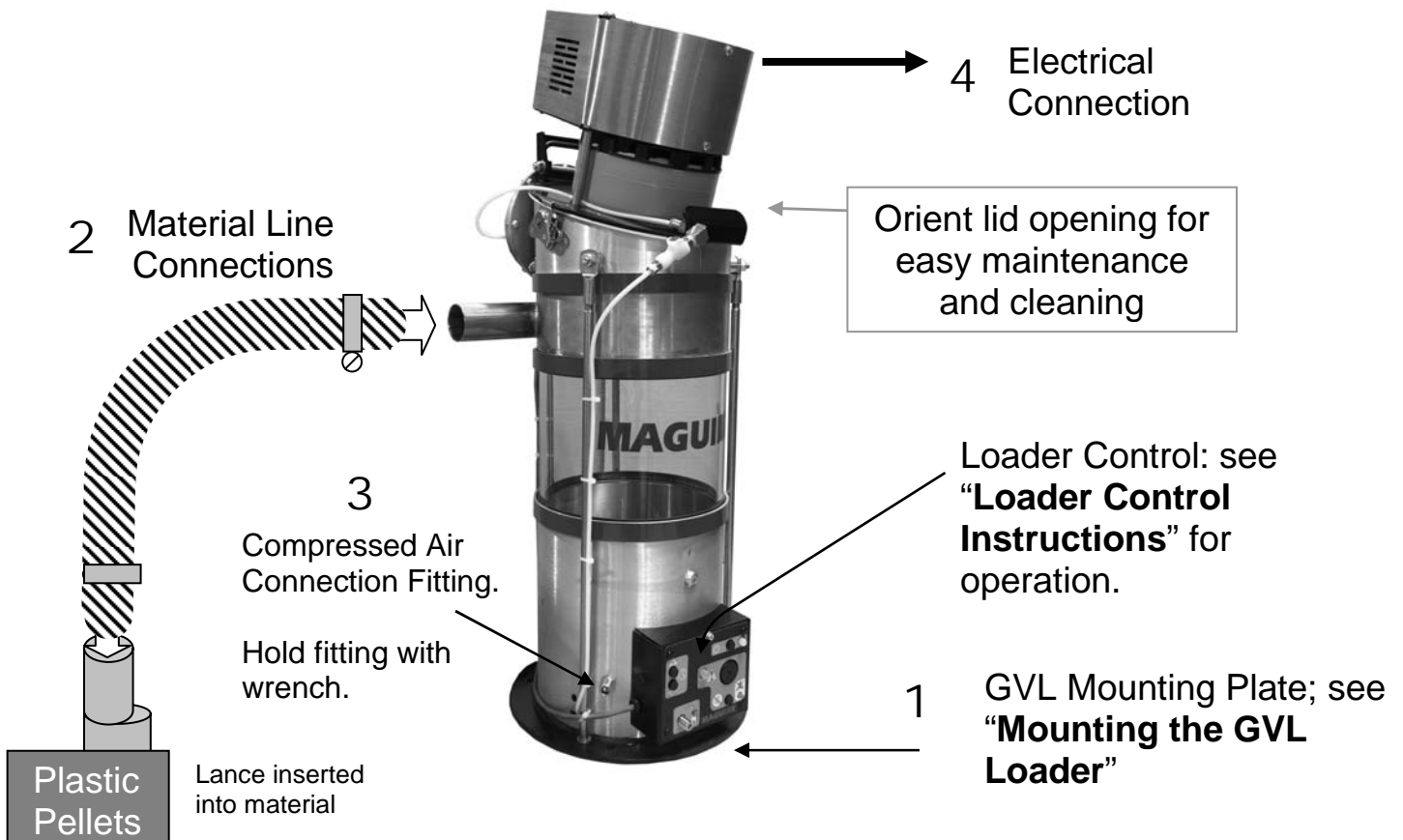

1. Mount the GVL-10 to your hopper. See drawing next page. Contact Maguire for available adapter plates.
2. Install material hose, secured with hose clamps at both ends, from the lance to material inlet tube of loader.
3. Install flexible compressed air line to the fitting and connect to clean, dry compressed air supply 80 psi.  
CAUTION: Use a second wrench to hold the fitting on the GVL secure while tightening the hose fitting.
4. Plug power cord into appropriate 120V power source.

# Mounting the GVL Loader

## GVL-10 Mounting Pattern

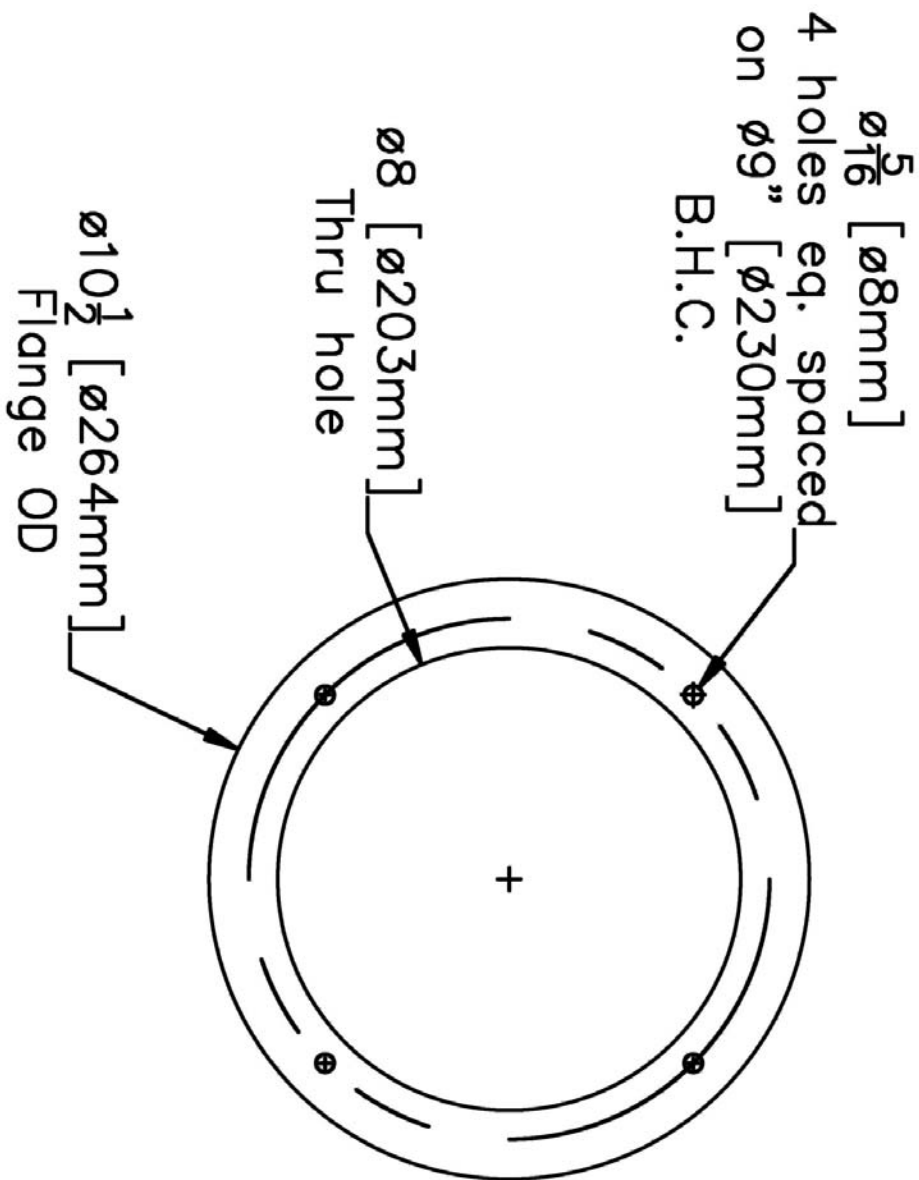

- Contact Maguire Products for available adapter plates.

# Operating the GVL GlassVu Loader

## --- General ---

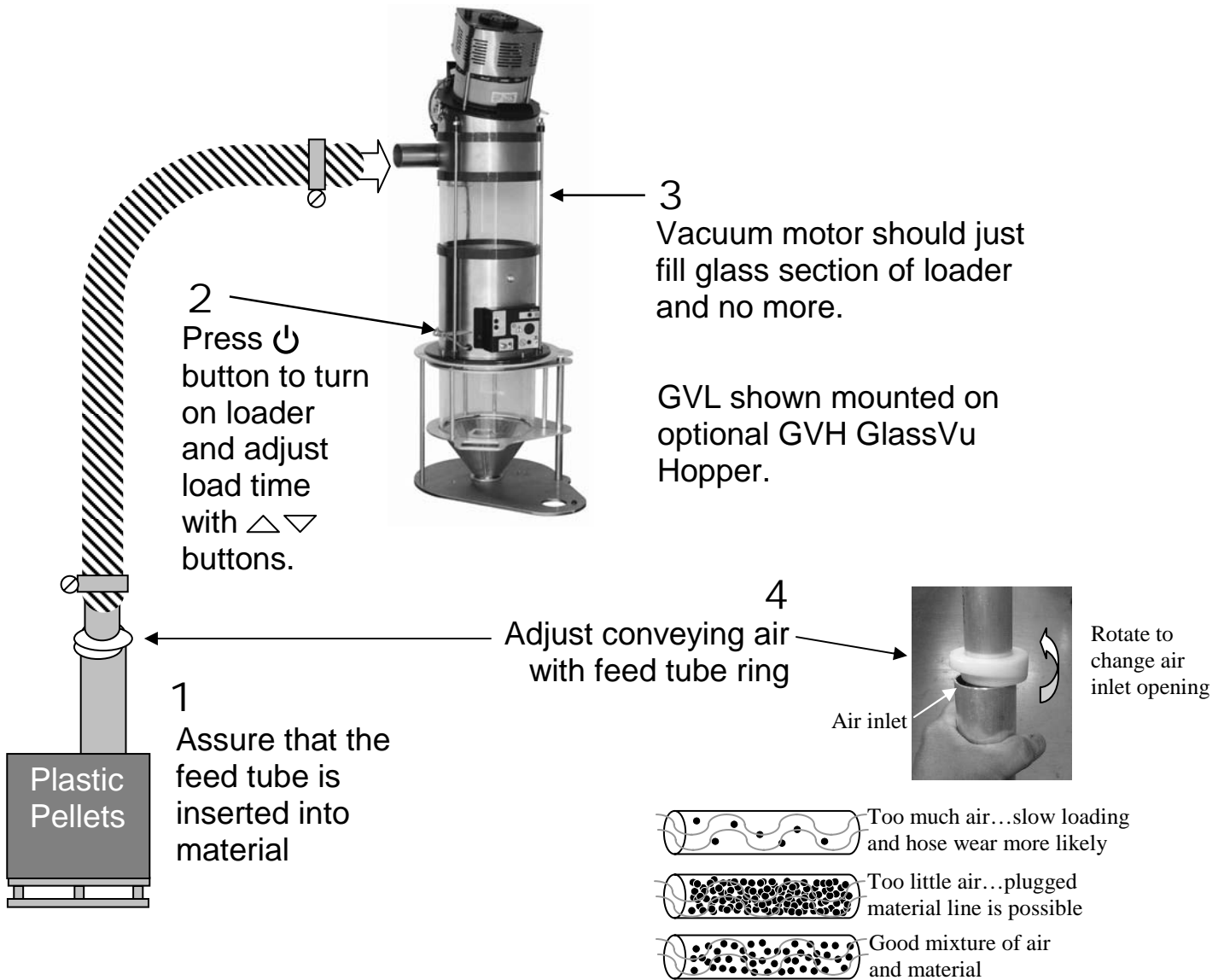

- 1 The feed tube joins air with material and it should be plunged (and kept) in the material supply, but allow upper section of feed tube to remain above material level.
- 2 Adjust load time. See next page for detailed instructions on control settings and options.
- 3 To allow optimum loading and longest filter life, adjust load time and feed tube settings so that material flows into loader consistently and fills to top of glass. Filling the loader to a higher level will encourage premature filter blinding.
- 4 Rotate the feed tube ring for the best air to material mixture. The best mixture of air and material will allow material to flow efficiently, with the right proportion of conveying air, without clogging and without rapid hose wear.

# Loader Control Instructions

## LOAD TIME

- Increase (+) or decrease (-) seconds of vac motor time
- Chirp confirms change
- One press = one second
- Pressing both buttons during loading will use that time setting

## POWER\*

- Press for On or Off
- Slow flash green = Power connected, unit turned off
- Steady green = On
- Fast flash green = Loading

## ALARM

- Red light and horn = Loading problem.
- Press silence button to turn off horn. Red light stays on until problem is solved or power button is pressed.
- Pressing silence button before alarm defeats alarm function.
- Yellow light = alarm is defeated

*\* The "power" button enables or disables loading. Power is only disconnected by unplugging the power cord.*

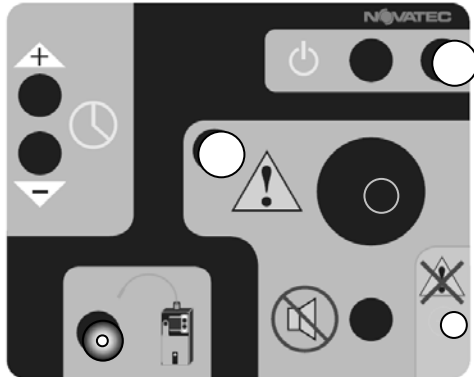

## LOADER CONTROL

*See next page for details on special keystrokes for detailed programming without pendant.*

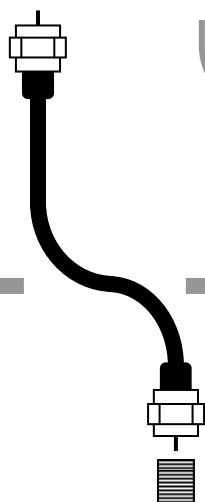

## Optional PENDANT Part Number: GVL-CP

### Connector Cable

*Pendant may be disconnected after changes are made with no loss of settings.*

## SELECT FUNCTION

- Button selects functions for viewing and/or changing.
- Selected function lights up, below.

## VIEW and CHANGE SETTINGS

- Value of the selected setting appears in window
- Increase (+) or decrease (-) values
- Display defaults to show "ON"
- Display shows "AL" for alarm condition

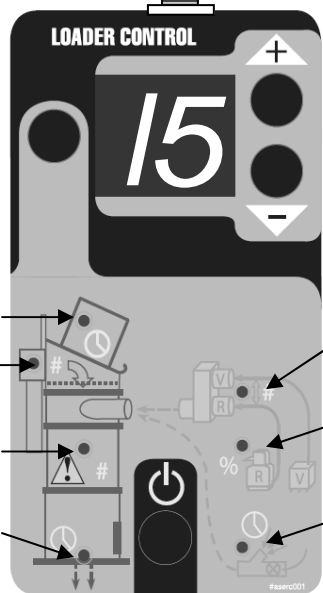

**LOAD TIME** (in seconds)

**FILTER CLEANING**  
Frequency and Number of pulses

**ALARM** - Number of load retries before alarm ("0" = alarm defeated)

**UNLOAD TIME**  
(in seconds or minutes M)

**PROPORTIONING LAYERS** - Number of Proportioning Valve changes per load

**PROPORTIONING % of REGRIND**  
Proportioning Valve is required for this function.

**PURGE TIME** - Seconds for material line clearing. A purge valve is required for this function.

## STANDARD FUNCTIONS

## OPTIONAL FUNCTIONS



## POWER\*

- Press for On or Off
- Display shows "ON"

*\* The "power" button enables or disables loading. Power is only disconnected by unplugging the power cord.*

# Making Detailed Control Changes Without The Use Of The Pendant

The optional control pendant is the easiest way to make detailed changes to the loader control parameters, but changes are also possible with special keystrokes on the loader control itself, as described below:

1. Enter set-up mode by pressing +, - and  at the same time.
2. Function selections are indicated by counting flashes of the yellow LED light (see list, below).
3. Hold  and press either + or - to move through the function list.
4. Once a function is selected, its values may be changed by pressing + or -.
5. Values of each function are indicated by flashes of the red light:
  - A short flash = a value of 1
  - A long flash = a value of 5
  - Example: a value of 16 = 3 long flashes and one short flash.
6. Press  to exit the set-up mode and return to normal operation.

The Red LED flashes to indicate the value of the selected Function:

Short LED Flash = 1  
Long LED Flash = 5

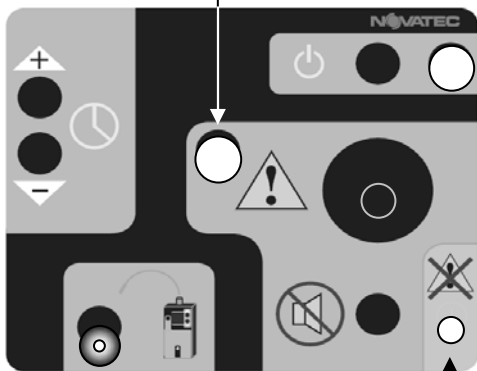

Green LED:  
Slow flash = Power connected, loader off  
On = Loader on, ready to load  
Fast flash = Loading (vacuum on)

The Yellow LED flashes to indicate the selected Function:

Short LED Flash = 1  
Long LED Flash = 5

## Loader Functions:

## Yellow LED flashes:

1	Load time (in seconds)	1 Short Flash
2	Filter Cleaning pulses	2 Short Flashes
3	Alarm after # of load retries	3 Short Flashes
4	Unload (vacuum off) seconds	4 Short Flashes
5	Purge Time in seconds	1 Long Flash
6	Proportioning % of Re grind	1 Long, 1 Short
7	Proportioning Layers	1 Long, 2 Short
8	Unload time (in minutes)	1 Long, 3 Short

# Description of Loader Functions

## Functions and Descriptions:

1	Load time	Set the load time to fill the glass chamber to the desired level. Load time can be set from 2 to 60 seconds.
2	Filter Cleaning	Two-digit number. First digit is the frequency, which is the number of loads between cleaning the filter. Second digit is the number cleaning pulses that will be applied.  <b>Frequency (1<sup>st</sup> digit):</b> Range 0 to 5 (0=after every load, 5=after every 5 <sup>th</sup> load)  <b>Number of Pulses (2<sup>nd</sup> digit):</b> Range 0 to 5 (0=no cleaning, off)
3	Alarm	Number of load retries before alarm sounds. Number of retries can be set from 0 to 19. Zero turns off alarm.
4	Unload	Unload time in seconds Range 3 to 59 seconds
5	Purge Time	Purge time in seconds. Range 0 to 15 seconds. Optional purge valve is necessary to use this function.
6	Proportioning	Is the adjustment of the % of Re grind. Range on loader controller: 0 to 10 (0 is 0%, 10 is 100%) Range on pendent: 0 to 100% by increments of 5%. V=0% Re grind, R=100% Re grind. Optional proportioning valve is necessary to use this function.
7	Proportioning Layers	When set via the controller, the number of layers is 0 to 5 layers. When set via the pendent, the number of layers is A thru 5 layers. A = Number of layers automatically adjusted based on load time. Automatic range is from 1 layers to 3 layers.
8	Unload Time	Unload time in Minutes Range 3 to 9 minutes (Must set to zero to enter a value less than one minute in function 4)

# Filter Cleaning or Replacement

1. Disconnect the Blowback airline.

Blowback Airline Disconnect.



2. Open the two butterfly latches and lift the lid.

Remove the filter for cleaning or replacement.





# Electrical Connection of Loading Options

- Proportioning Valve
- Purge Valve
- Output to Auxiliary Alarm Device

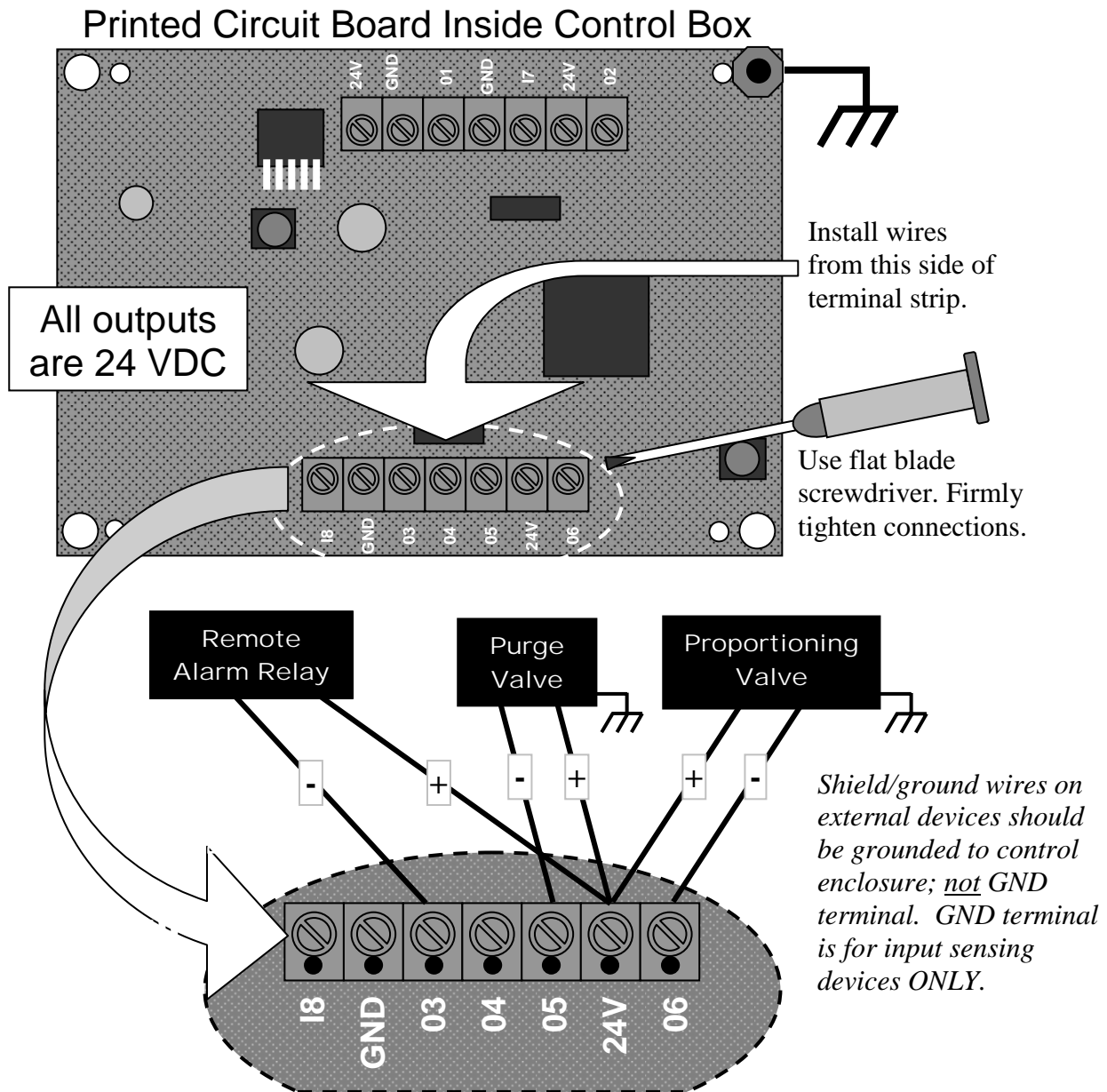

1. Remove the screw from the top of the loader control enclosure, and carefully tip the enclosure out without straining wires connected to the control.
2. Locate the correct terminals for the device you are connecting, as shown above and connect the wires carefully. Use care as some terminals accommodate multiple wires.
3. Route the cable out of the control box, through one of the slots in the side. Tightly install a tie wrap (not included) onto the cable, inside the control enclosure to prevent the cable from being pulled out of the box.
4. Tip control box back into place and tighten top screw.

# Accessing the Vacuum Motor for

- Inspection of motor or power supply
- Motor replacement
- Brush replacement

## Loader Model GVL-10

For easiest service, the entire motor lid may be removed from the loader by first disconnecting the power cable from the supply and unplugging the round connector that connects to the loader control. Then remove the hinge bolt, freeing the lid to be removed from the loader body.

- 1 Remove 4 screws from the top and one screw on the front of the motor cover and remove the top cover plate (may require prying to separate the cover plate from the plastic motor shield).
- 2 The motor, power relay and power supply are now exposed for inspection.
- 3 The entire motor housing may be lifted away from the motor by lifting straight upward and sliding it along the smooth support shafts.

3A: Sleeves covering the support shafts will be drawn up and become loose when the motor housing is raised. These sleeves must be replaced when the motor housing is reassembled.

3B: For motor replacement and/or ease of service, the motor wires (2 black wires, plus ground) should be disconnected, freeing the motor from the motor housing.

3C: Clearance slots in the lower panel of the motor housing allow the housing to be slipped around the protruding brushes and removed (the motor may require rotating to align the brushes with these slots).

The motor is now separated from the lid and housing for service or replacement.

- 4 To re-assemble, reverse steps 1 thru 3 above, but be sure the motor is properly centered and seated within the lower panel of the motor housing. Move motor as necessary to fit the motor ledge within the housing.

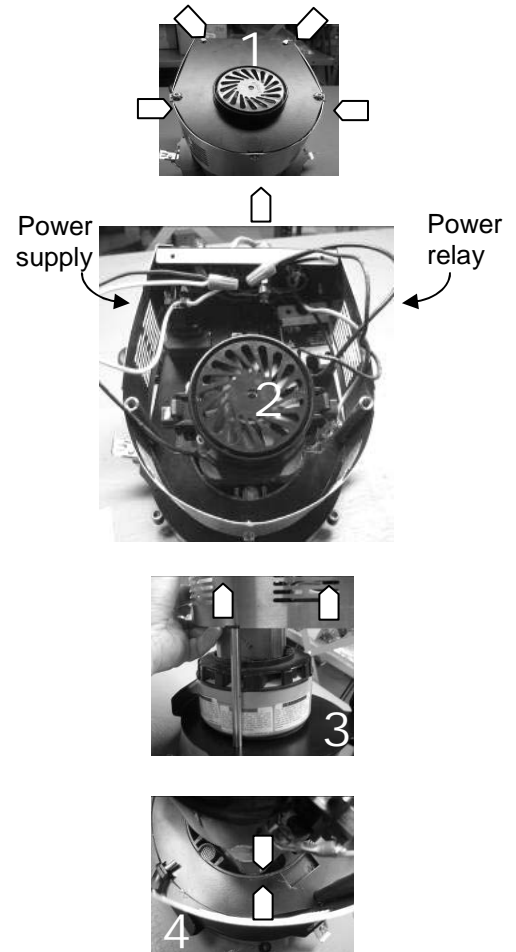

# Replacing Motor Brushes

## Loader Model GVL-10

See "Accessing the Vacuum Motor" to remove cover from motor.

- 1 Remove plastic shield from top of motor by squeezing the top of each spring clip (A) while prying the cover up away from colored brush holder (green-120 volts, red-220 volts). Cover can be worked up and off, one side at a time. Take care to not break small positioning stubs and grip tabs (B) on the plastic cover.
- 2 Remove two black screws that hold down brush retaining clip. Once removed, brush will be released, but still connected to the short electrical lead. Use caution to avoid damaging the lead.
- 3 Pry electrical lug out of the brush holder in the direction of the motor armature, taking care to not separate the wire from the lug.
- 4 New brush may now be connected to the electrical lead by reversing this procedure. Push the lug firmly between the brass brush holder and its plastic housing.
- 5 Reinstall new brush into motor housing and replace the retaining clip. Be sure to properly seat the nub on the bottom of the brush holder into the motor housing groove.

Repeat steps 2 thru 5 for the adjacent brush.

Replace the plastic shield on top of the motor by aligning it on top of the motor and pushing down until the spring clips on each brush snap into place. Reinstall cover over motor.

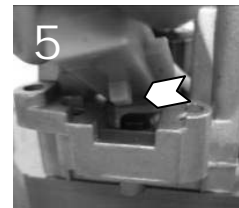
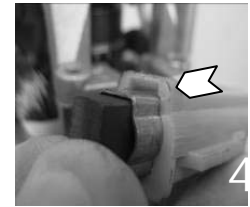
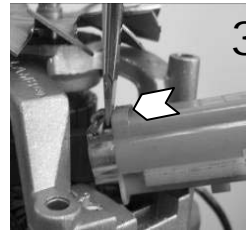
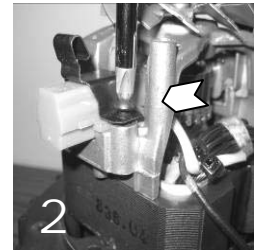
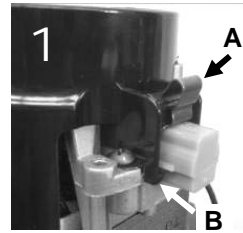

# Spare and Replacement Parts

Model: GVL-10

*Note: Part numbers are case-sensitive*

Part Description	Part Number	#
Lance Assy w/Reg, 1.5" OD	as1714-NV	1
Vacuum Hose...1.5" ID*	tpvc24	2
Hose Clamp	hhc24	3
Vacuum Motor...115 Volts*	m2M266	4
Vacuum Motor...230 Volts*	m4M915	5
Motor brushes...115 volts*	mb06	6
Motor brushes...230 volts*	mb07	7
Rubber gasket, lid to motor	NL8-R1	8
Motor cover (stainless grill)	NL8-02W	9
24 VDC Power Supply	ef27	10
Solid State Relay for motor	ehr11	11
Fuse, 10A for 115 volts*	ez-10	12
Fuse, 5A for 230 volts*	ez06	13
Multi pin connector (F)	epgm02	14
Lid gasket (under lid)	NR8-R2	15
Filter, Dacron disk, 7 7/8" OD*	hfdd8	16
Filter Support Ring	NR8-02R	16b
Butterfly latch (2)	hl09	17
Segment ring (alum, T profile)	NR8-38	18
Material Inlet Ring, 1.5"	asNL8-03	19
Glass gasket (top or bottom)	rpl-6-4	20
Glass cylinder...for GVL-10	NR8-G6	21
Air Cylinder for discharge	ncy2-P	23
Discharge rubber gasket*	NR8-R1	24
Discharge valve top plate	NR8-12	25
Solenoid, 4-way, 24 VDC (2)	nv50-24D	26
GVL control printed circ board	eabNL-01	29
Coax Cable-25 feet w/ tie wrap*	ehcx25	30
Control Pendant with cable*	GVL-CP	31
Diaphragm Valve, blowback	NL8-53	32
Spring, blowback	hs33	33

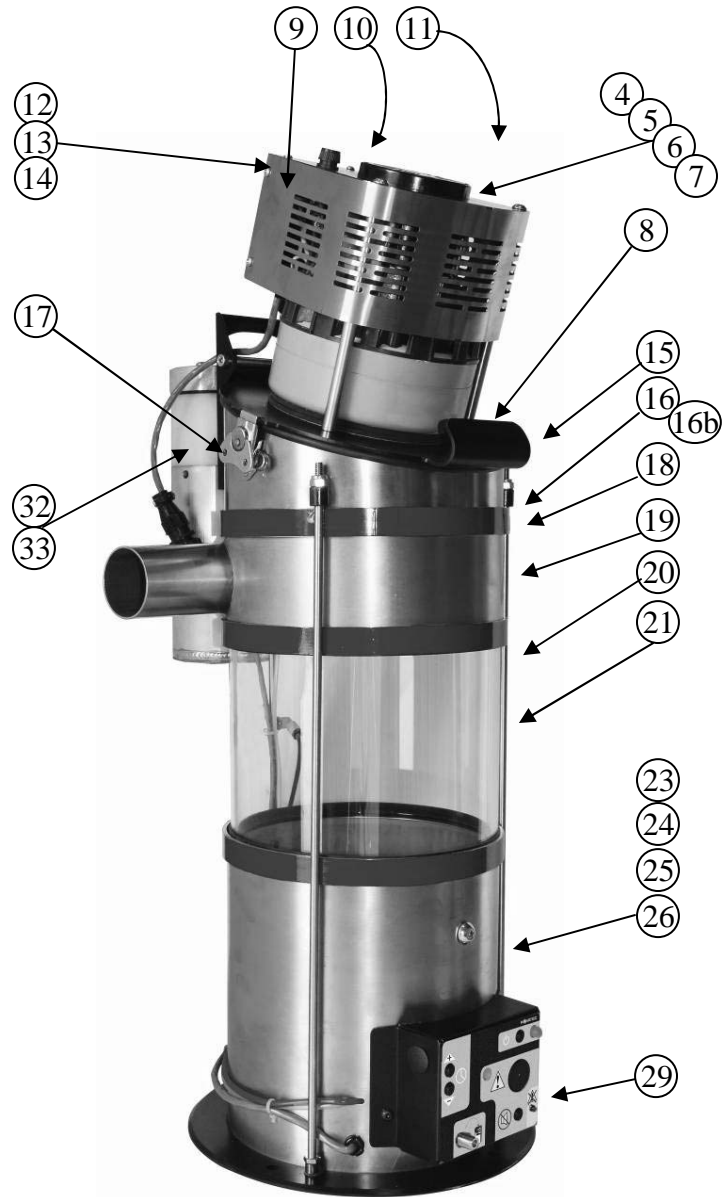

\* Recommended Spares

*See alternate prints/manuals to find parts for associated equipment or options*

