

LIW-25 + OPXS-LIW-M
or OPXS-LIW-S
("M" includes HMI)

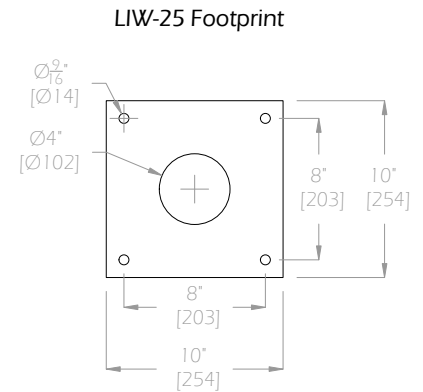
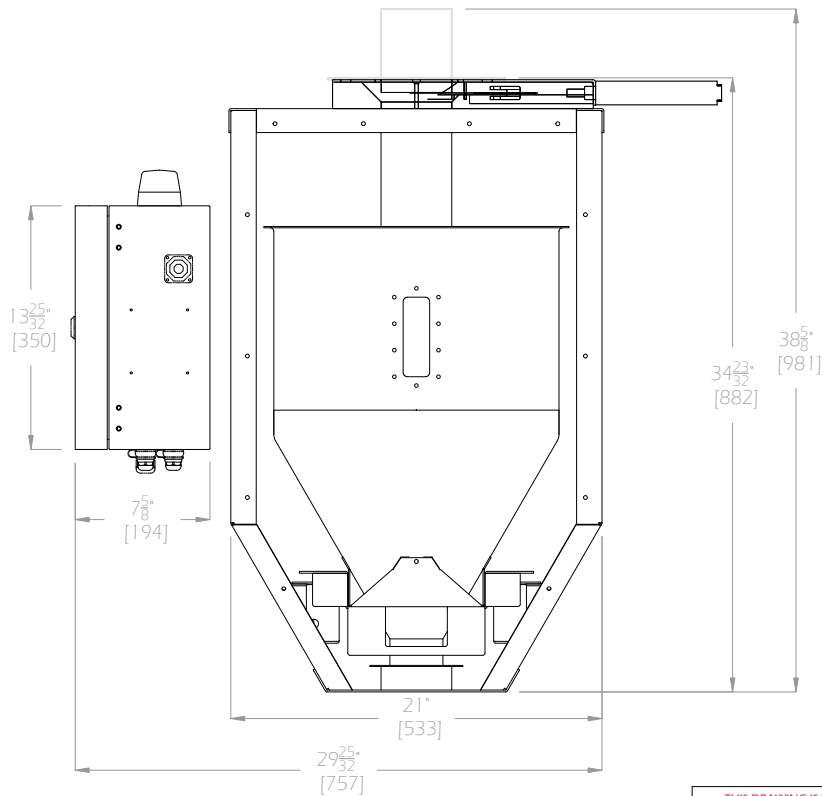
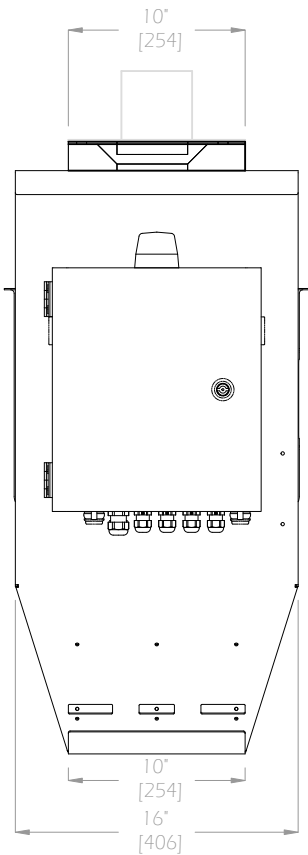
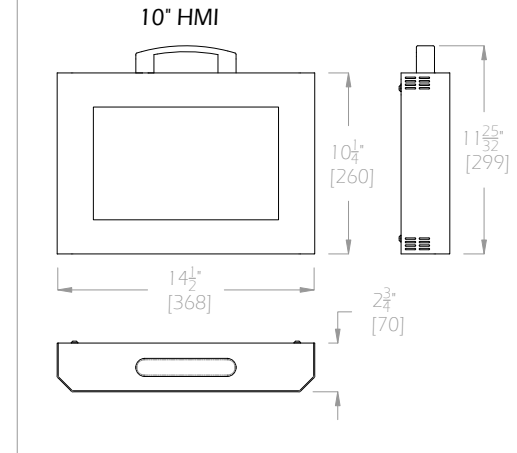
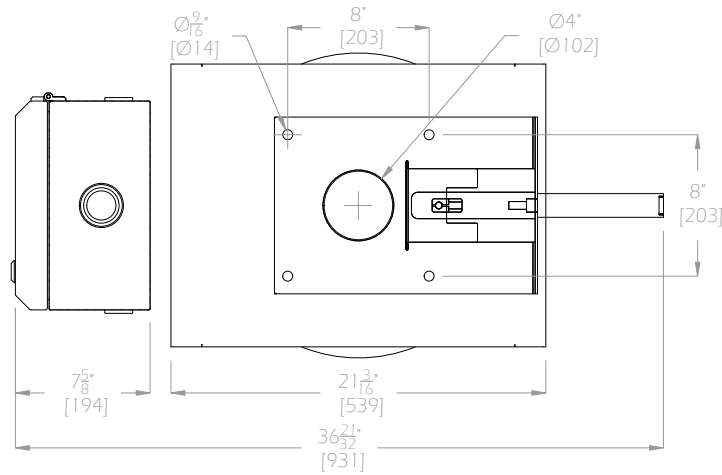

THIS DRAWING IS THE PROPERTY
OF MAGUIRE PRODUCTS INC. AND
MUST BE RETURNED ON REQUEST
IT MUST NOT BE COPIED OR
PASSED TO A THIRD PARTY.
DRAWING IS NOT TO SCALE.

TITLE	
LIW-25	
DRAWN	FF
DATE	16/04/2020

MAGUIRE[®]
Intelligent Simplicity