

# THE COMPLETE MGF FEEDER LINE

---

Eliminate waste  
of **colorants** and  
**additives**.



PRODUCT GUIDE



“

Choosing the right equipment could lead to significantly more savings and more production flexibility well into the future.

”



# MGF Overview

# Ready, Set, Go...

Maguire has long term experience in gravimetric dosing – the MGF provides a robust hardware integrated with industry leading software control to provide consistent accuracy that simple and easy to use, backed with a 5 Year Warranty.

**1 Simple Setup Procedure**

Enter the percentage setting and then either the molding shot weight or extrusion throughput and then the MGF Feeder automatically doses.

**2 Fast Material Change Over and Clean Out**

The hopper is easily removed without need for tools by releasing 2 latches – this allows unused material to be removed and rapid cleaning prior to a next job start-up.



**3 High Heat Applications**

The MGF Feeder has a high temperature option for working in high heat applications like PET, designed to isolate heat transfer to masterbatch or additives.

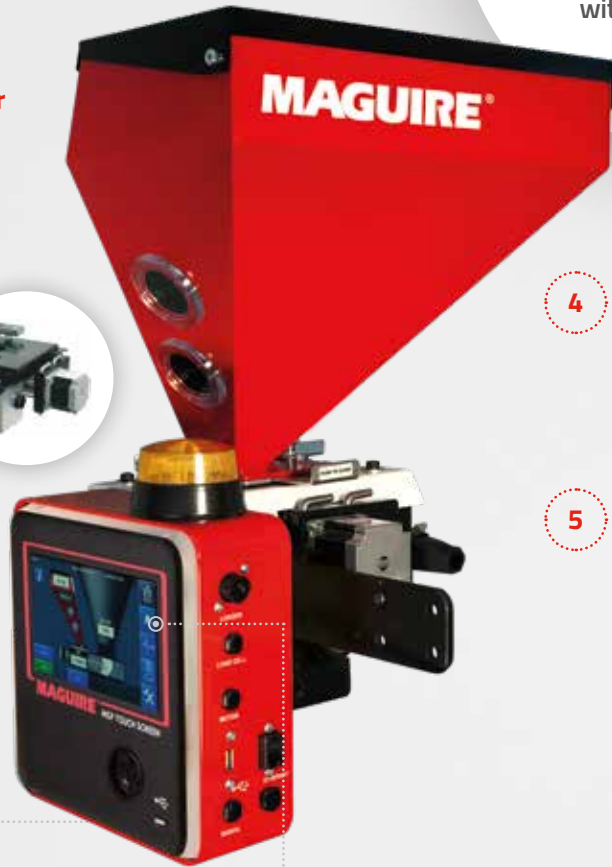

**4 New MGF Touchscreen Control Option Available**

User-friendly controller features a 7" full color and fast response touchscreen.

**5 Modular Design**

Design allows key components to lock together. Easy disassembled for cleaning and reassembled for next job. No tools required.



**Ready** - Load with masterbatch  
**Set** - Let-down ratio: in shot weight or lb/hr  
**Go** - System automatically re-calibrates as it doses



# What makes the MGF Gravimetric Feeder unique?

## 01 | Prime

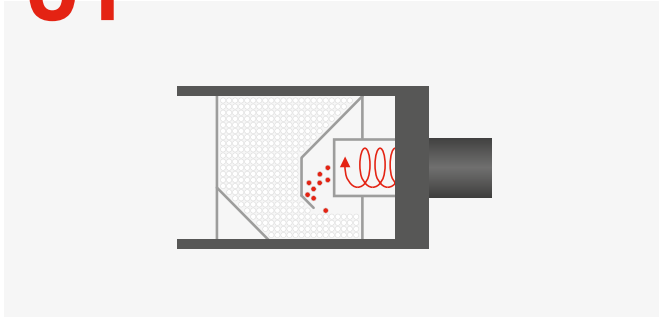

PRIME, a patented solution by Maguire, allows for instant calibration by filling the screw and barrel with material ready to start production. While the screws and barrel are being primed, grams per revolution of the material is calculated prior to start of production.

## 02 | Accuracy ± 0.2%

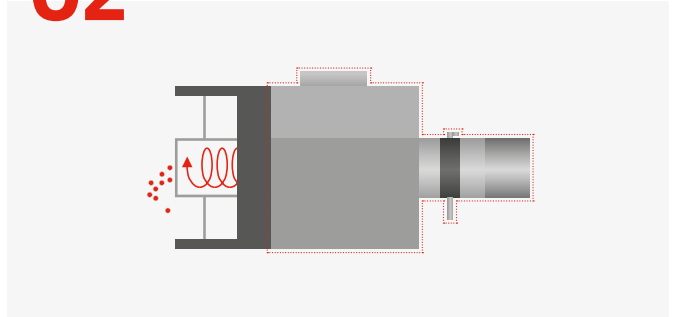

Automatic re-calibration during production guarantees that feed rate is held to within ± 0.2% of desired let-down ratio.

## 03 | Stepper Software Control

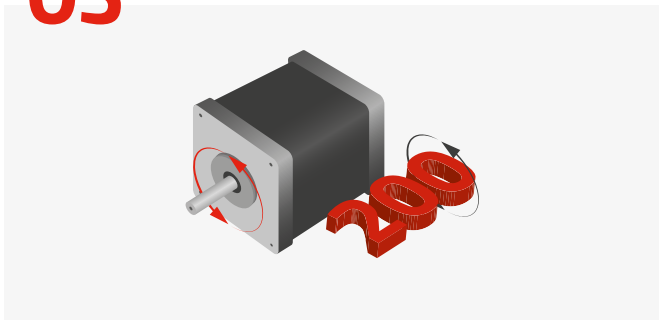

The MGF Feeder is fitted with a stepper motor that advances at 200 increments per revolution. Combined with the software this allows accuracy of ± 0.2%.

## 04 | Twin Load Cell

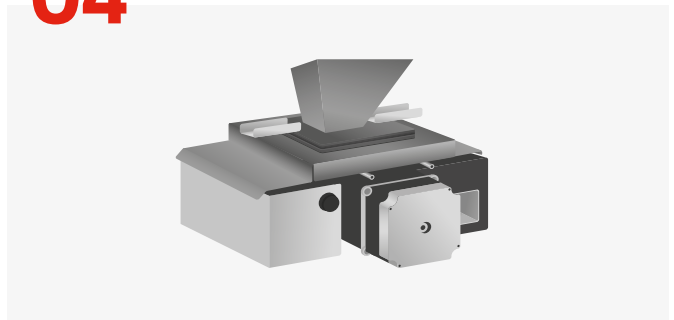

The MGF Feeder material hopper is mounted on 2 load cells which measure the weight of the hopper and material, constantly updating the loss in weight as material is dosed. This allows use of load cells with fine resolution which assists in accuracy and control, versus weighing the complete feeder assembly.

## 05 | Interchangeable Dosing Screws

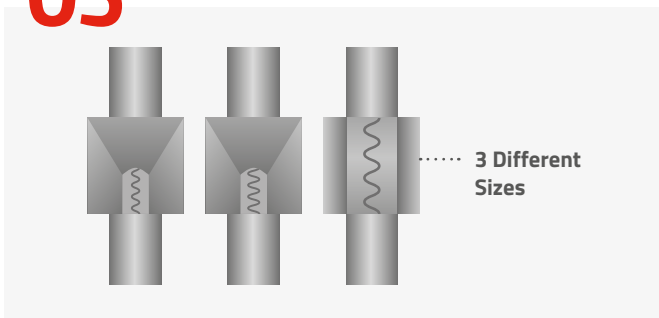

The MGF Feeder has a choice of dosing screws that combined with the software control provide industry leading accuracy compared to any other type of dosing device available in the market.





## 06 | Data



Consistent color dispense during entire process for increased color accuracy backed up with data.

# Gravimetric Feeding Solutions for all Molding Applications

High precision Gravimetric Feeders. Suited to all types of molding process.

-  Automatic calibration
-  Vibration management built into software
-  PRIME, a patented solution by Maguire
-  Options
  - Venturi loading
  - Dosing sensor control
  - High heat option
  - Touchscreen option
  - MPM pre mixer
-  Easy access



## 100% Injection Coloring\* (MGF-X-STI)

When accuracy for the entire shot is essential for critical additives, colors and tinting.

### New control mode for injection molding

- 2 signals: Screw back / recovery Signal (SR) AND Injection Signal (I)

### 100% dispersion achieved through control algorithm

- 75% dose on recovery, 25% dose on injection

### Consistent coloring

- All material in barrel is now colored
- Eliminates the gaps as shown below

### Shots In Barrel

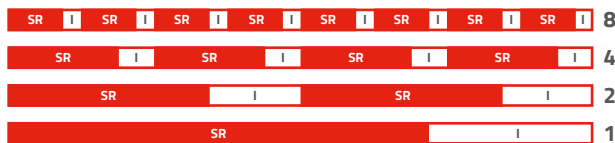

\*Patent Pending

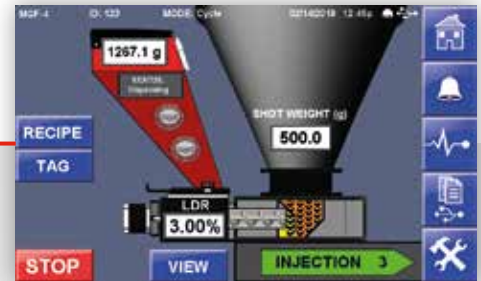

## Machine Integration: MGF Configuration – ST vs. STV

### MGF ST

(Typically newer injection molding machines and extrusion lines)

- The standard MGF ST stepper configuration can be used for either injection or extrusion applications
- The injection mode utilizes a dry contact signal as a means of detecting the plastification time
- The extrusion mode input will accept a 0-10 VDC proportional signal from the extruder drive

VS.







### MGF STV

(Typically older injection molding machines)

- The V suffix represents voltage and is a different circuit board which does not have extrusion following capability
- This model is injection only
- The input circuitry is voltage sensing (24-120 Volt Injection)

# Gravimetric Feeding Solutions for all Extrusion Applications

There are a variety of options with our MGF Feeders to suit your processing needs.

-  Automatic calibration
-  Extrusion following 0-10 V
-  PRIME, a patented solution by Maguire
- 
**Options**
  - Venturi loading
  - Dosing sensor control
  - High heat option
  - Touchscreen option
  - MPM pre mixer
-  Easy access
-  Vibration management built into software

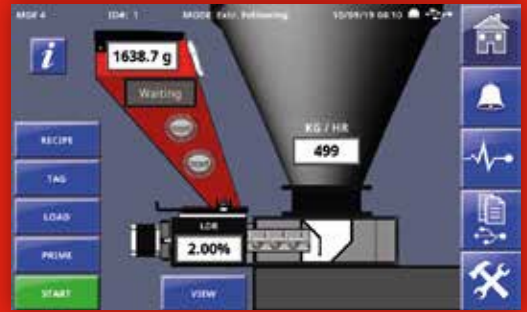

## Plus Complete Extrusion Control Options



- 1

**Integrated Dosing & Extrusion Control**

  - Precise dosing masterbatch
  - Loss in weight updates every second process consumption
- 2

**Solutions for many Extrusion Processes**

  - LIW + MGF solutions can bring major benefits to Blown Film and Cast Film Processes
  - Sheet Extrusion
  - Pipe, Profile & Tube Extrusion
  - Cable & Wire Extrusion
- 3

**Extrusion Control – Saving up to 10% of Materials Cost**

  - Switching from manual regulation to automatic extrusion control allows significant savings
  - Savings by reduced start-up material waste & changeover scrap
  - Immediate control by responding to actual material consumption versus target required
  - Rapid return on investment
- 4

**Maguire+Syncro Control Flexibility**

  - Detailed control of materials settings, layer ratio control & extrusion control
  - Control allows effective control for mono and co-ex processes, managed from 1 HMI
  - Modular upgrades available for air rings, IBC, gauging and wide range of control options for optimizing different extrusion processes



## 6 New feeder lines

### A multitude of configurations

- Complete application flexibility with 5 new choices of gravimetric feeders
- The new gravimetric feeder line can be configured in any optimal way to accommodate various processing requirements.
- Allows for up to 4 different size auger feeders, all located on one mounting frame, using a single common touch screen control.
- Providing the ultimate flexibility for injection molding, extrusion, blow Molding and extrusion control applications.
- Save tens of thousands of dollars per year through accurate dispensing of color and additives.
- The series offer unique twin load cell technology with a dosing accuracy of  $\pm 0.2\%$ .

#### Control at your fingertips

- ✓ PRIME calibration
- ✓ High accuracy
- ✓ Dual load cells
- ✓ Fast material changes
- ✓ Stepper motor control
- ✓ Modular design
- ✓ 100X Color Inject
- ✓ Integrate to any process built in - no extra cost
- ✓ Process data
- ✓ 5 Year warranty
- ✓ Rapid return on investment

MOLDING

EXTRUSION

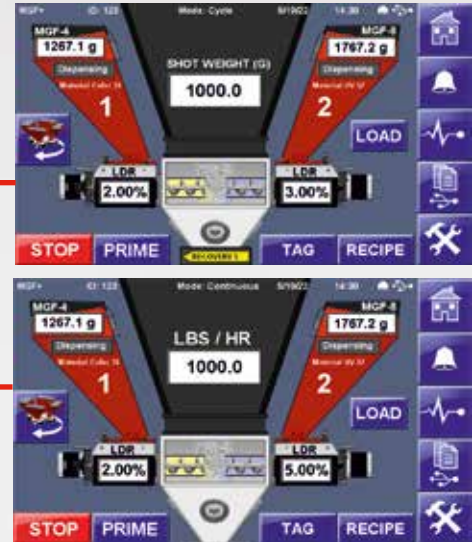

## Single Material Feeders

### 01 | MVF



#### Maguire MVF - Volumetric feeder

- Processors can also now choose from Maguire's latest, most economical version of their volumetric feeder, the MVF.
- The MVF is designed for simple volumetric dosing of color concentrate and/or additive material.
- It utilizes a simple (digital push button) setpoint control and a stepper motor to provide consistent letdown ratio without any use of load cells.
- Conversion kits are available for upgrade to full gravimetric capability.

### 02 | MGF



#### Maguire MGF

- The MGF gravimetric feeder is well established in both extrusion and molding applications.
- Fully automatic single material feeder with rapid learning and self-calibration utilizing a pair of load cells.
- The MGF system is easy to install, maintain, set and change Color or Additive.
- Control software integrates a range of easy integrations to every process which is easy to implement and no additional cost.

## Multi Material Feeders - Molding

### 03 | MGF+



#### Maguire MGF+ line

- The new Maguire MGF+ line incorporates the standard gravimetric feeder options and includes up to (4) different size auger feeders on one mounting frame all using a common touch screen control.
- Allows the flexibility to dispense multiple additives/color/materials within one frame and one controller.
- Center hopper dispenses the virgin material.
- Each unique feeder the dispensed material is measured precisely and accurately to maintain the correct desired percentage – all controlled by one touch screen controller.

### 04 | MVF+ 100B



#### Maguire MGF+ 100B

- The MGF+ 100B is ideally used in injection molding applications.
- This model has no center hopper so that all materials must run through the feeders.
- This model includes a material collection bin with a level sensor that maintains material level by activating the dispense of the materials on demand.

## Multi Material Feeders - Extrusion

### 05 | MGF+100L



#### Maguire MGF+ 100L line

- New Maguire MGF+ 100L incorporates up to (4) different size auger feeders.
- MGF+ system adds a main material loss in weight hopper to ensure all materials processed are accurately weighed and controlled via one controller.
- As all materials are 100% weighed and the additive components are ratioed to the primary component, regardless of changing throughput.
- This series is ideal for extrusion processes.

### 06 | MGF+ 100X



#### Maguire MGF+ 100X

- Maguire MGF+ 100X takes the process control one step further by including an extrusion control package.
- The extruder drive control is managed with the same touch screen controller as the hopper and the feeders.
- This model used exclusively for extrusion applications streamlines the entire process and includes the center loss-in-weight (LIW) hopper along with up to four auger feeders.
- The LIW controller monitors the actual throughput of the line.
- The target throughput is set on the controller and when the operator switches to automatic mode, the controller will adjust the extruder drive to maintain target weight per hour and/or weight per length.

# MGF Specifications

## Throughput Capacity

### Extrusion Applications

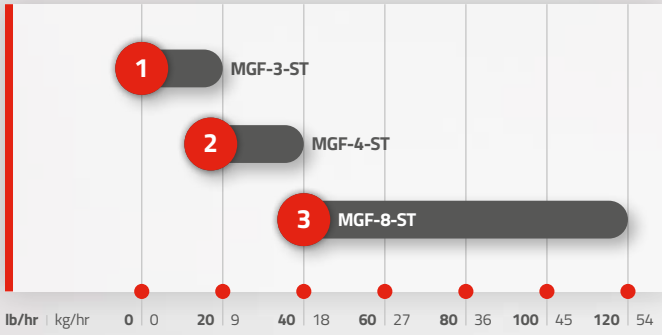

Extruder throughput per hour x LDR = additive addition rate

### Molding Applications

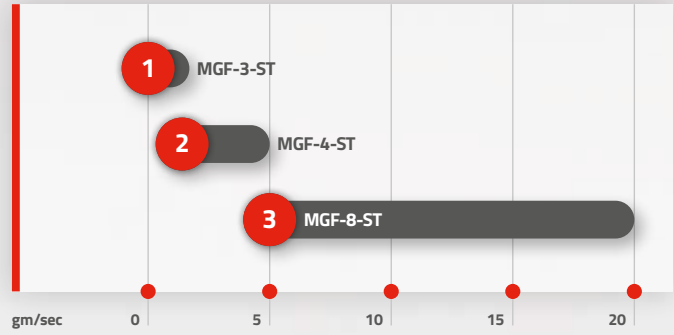

Shot size x LDR / screw recovery = grams/second

EXTRUSION	MGF-3-ST		MGF-4-ST		MGF-8-ST	
Auger Diameter	3/8"	9.5 mm	1/2"	12.7 mm	1"	25.4 mm
Minimum Rate lb/hr*   kg/hr*	0.4	0.18	0.6	0.3	4	1.8
Maximum Rate lb/hr*   kg/hr*	8	3.6	40	18	120	55

MOLDING	MGF-3-ST		MGF-4-ST		MGF-8-ST	
Auger Diameter	3/8"	9.5 mm	1/2"	12.7 mm	1"	25.4 mm
Rate Gram / Sec	0.02 - 1		1 - 5		5 - 20	
Minimum Dispense Gram	0.25		0.5		5	

\*Based on material density of 55 lb/ft<sup>3</sup> (881 kg/m<sup>3</sup>)

## Control Modes

MODEL	PROCESS	OPERATION MODE	INTERFACE
MGF-X-ST	Molding	Cycle	Dry contact to monitor screw recovery time automatically
MGF-X-STV	Molding	Cycle	24 V to 120 V signal interface to monitor screw recovery time automatically
MGF-X-STI	Molding	Cycle	100% Color inject feature, monitor screw back & inject signals
MGF-X-ST	Extrusion	Continuous	Feeder automatically doses according to extrusion throughput reference entered in control
MGF-X-ST	Extrusion	Extrusion Following	Feeder follows 0-10 V interface signal of extruder to ensure correct setting as throughputs increase / decrease
MGF-X-ST	Extrusion	LIW	Follows complete process data from LIW Live

## MGF-ST Dimensions

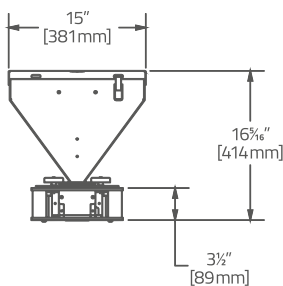

FRONT VIEW

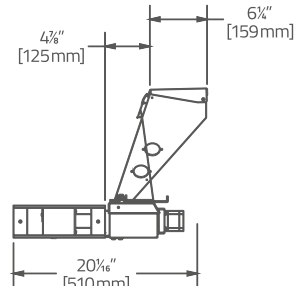

SIDE VIEW

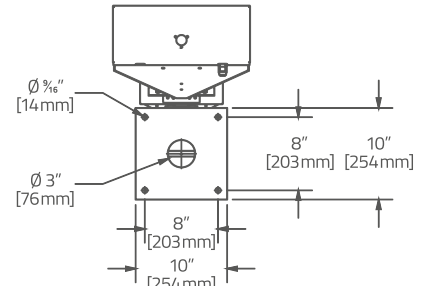

TOP VIEW

# MGF Options



MGF MACHINE MOUNTING FRAMES				
MODEL	THROAT MOUNTING ADAPTOR	FRAME	FEED HOLE	MATERIAL BAFFLE WITH SIGHT WINDOW
865-40	For smaller injection molding machines and extruders	-	-	-
SGF-3	For large extruders and injection molding machines	Black square 10" x 10"	3"	Included with MGF - only additional frames
SGF-4	Throat adapter	Black square 10" x 10"	4"	In lieu of SCF standard
SGF-5	Throat adapter	Black square 10" x 10"	5"	In lieu of SCF standard
OPF-P40 <sup>2</sup>	Pedestal throat mount adapter	Black square 8" x 8"	3"	In lieu of SCF frame

MGF-ST REMOTE CONTROLLER & LOADER KIT EXTENSION KITS	
MODEL	CABLE DROP
AEK-GSC-05	5 ft (1.5 m)
AEK-GSC-10	10 ft (3 m)
AEK-GSC-20	20 ft (6 m)
AEK-GSV-05	5 ft (1.5 m)
AEK-GSV-10	10 ft (3 m)
AEK-GSV-20	20 ft (6 m)

MGF SINGLE MATERIAL GRAVIMETRIC FEEDER - MGF SCREW CONVERSION KITS		
MODEL	CONVERT TO	STEPPER MOTOR
kitF-001	3/8" Auger	Without
kitF-001M	3/8" Auger	With
kitF-002	1/2" Auger	Without
kitF-002M	1/2" Auger	With
kitF-005	1" Auger	Without
kitF-005M	1" Auger	With

HIGH HEAT OPTION	
OPF-MGT Feeder Option	High temperature auger tube assembly (aluminum with cooling fins)
MGF High Temperature	Includes high temperature SGF frame (acrylic windows replaced with stainless steel)

MGF REMOTE ALARM	
OPF-GRA	Factory Fitted USA
kitF-003	Field Retrofit

**MGF-VENTURI LOADER SYSTEM - COMPACT VENTURI LOADING USING COMPRESSED AIR FOR LOCAL CONVEYING OF ADDITIVE / MASTERBATCH GRANULES FOR UP TO 12 FT / 3.6 M CONVEYING.**

AGL-ST	Stepper Motor
--------	---------------

**Cost effective loading solutions**, ensures dosing accuracy of  $\pm 0.2\%$  of set point. Loader is automatically activated by the MGF controller

**MPM PRE MIXER OPTION**

MPM2-15

Automatically and continuously mixes masterbatch or additives dosed by the MGF as they enter the process machine. Easy view of mixing, easy cleaning, minimize color usage

# MGF Touchscreen Controller



## Benefits of Upgrading...

...from Microprocessor to Touchscreen Controller  
 All features & functions of the Microprocessor controller + **intuitive, user-friendly 7" touchscreen.**

- Easy settings via digital thumbwheels
- Backlit LCD display
- Multilingual display
- Can be mounted remotely with optional extension cables
- Password protection
- Alarm light to indicate low-load (2-3 lb) in hopper
- USB port - software updates, files and usage reporting
- Data collection via G2 network software, or MLAN protocol via Ethernet

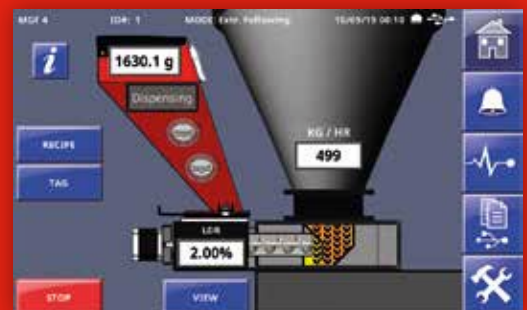

# Maguire Tracker Software

## Features

- Communicate directly with Maguire equipment
- Able to connect with WSB Blenders, MGF Feeders, ULTRA Dryers and FlexBus Conveying Systems
- Optimise plant materials handling before the process with easy to use and clear visualisation plus reporting



### WSB Gravimetric Blenders

- Send recipes & formulations remotely
- Check materials percentages & usages for accuracy
- Check materials consumption and report
- Review system setup & operation
- Report on materials usage and consumption data
- Review alarms & process interactions



### WSB Gravimetric Blenders

- Send recipes & formulations remotely
- Check materials percentages & usages for accuracy
- Check materials consumption and report
- Review system setup & operation
- Report on materials usage and consumption data
- Review alarms & process interactions







### WSB Gravimetric Blenders

- Send recipes & formulations remotely
- Check materials percentages & usages for accuracy
- Check materials consumption and report
- Review system setup & operation
- Report on materials usage and consumption data
- Review alarms & process interactions



### WSB Gravimetric Blenders

- Send recipes & formulations remotely
- Check materials percentages & usages for accuracy
- Check materials consumption and report
- Review system setup & operation
- Report on materials usage and consumption data
- Review alarms & process interactions

	CODE	DESCRIPTION
 MAGUIRE TRACKER HUB	MGT-HUB	Base Unit for plantwide communications – one off charge
 TABLETS AND MOBILE PHONES	MGT-APP	Subscription for day to day communications / secure encrypted data storage / rolling software updates - \$* per month subscription for up to 10 controllers - scalable fee for more systems
 DATABASES AND THIRD PARTY DATABASES	MGT-DBC -V1	Third party database plugin to allow integration to other third party databases based on OPC-UA
 TECHNICAL SUPPORT	MGT-TEC	Remote Technical support for specific remote access support after initial start-up period of 90 days – purchased online in half day units



“

**ON TWIN LOAD CELLS, OUR  
MGF OFFERS SOLUTIONS  
FOR EVERY APPLICATION.  
ON BALANCE WE'RE BETTER.**

**STEVE MAGUIRE, FOUNDER AND PRESIDENT  
MAGUIRE PRODUCTS INC.**

”

**[WWW.MAGUIRE.COM](http://WWW.MAGUIRE.COM)**

**MAGUIRE**<sup>®</sup>  
*Intelligent Simplicity*

 @MaguireProducts |  Maguire-Products |  MaguireProducts | [info@maguire.com](mailto:info@maguire.com) | [www.maguire.com](http://www.maguire.com)

USA Toll Free: +1 888 459 2412 | CANADA: +1 905 879 1100 | EUROPE: +44 1827 338 280 | ASIA: +65 68487117 | IMEA: +971 4 817 0419 | TAIWAN: +886 4 2658 1535